

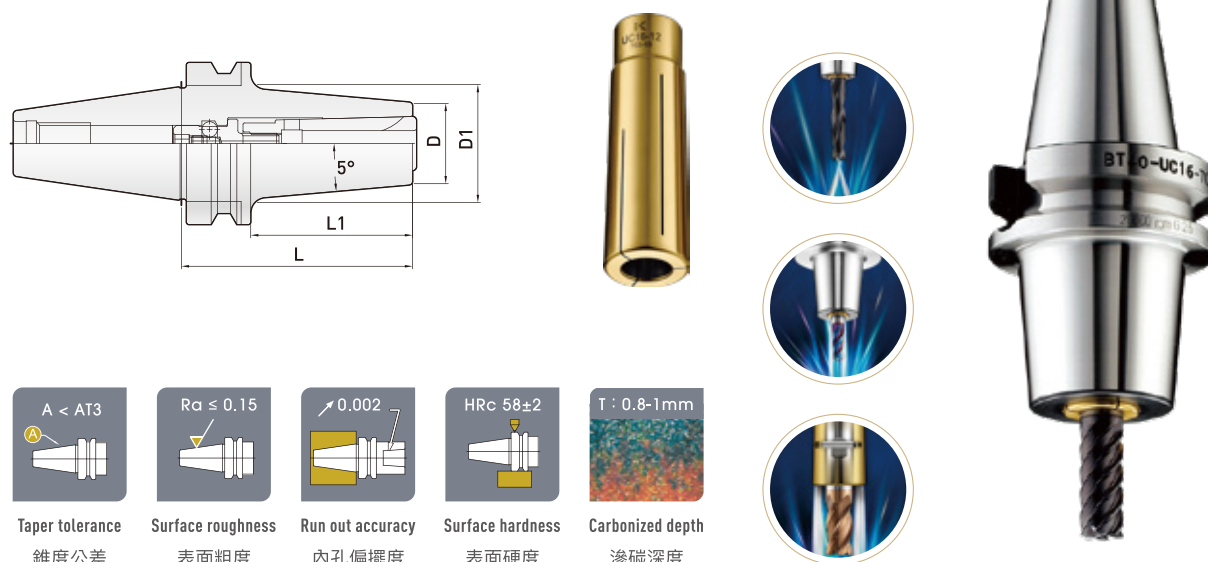



UC GOLD CHUCK (UC20) High Vibration Damping Type

UC 黃金夾頭刀柄 (UC20) 高阻尼減震型

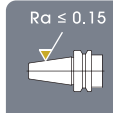
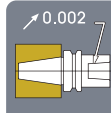

- 
A < AT3
 Taper tolerance
 錐度公差
- 
Ra ≤ 0.15
 Surface roughness
 表面粗度
- 
0.002
 Run out accuracy
 內孔偏擺度
- 
HRc 58±2
 Surface hardness
 表面硬度
- 
T : 0.8-1mm
 Carbonized depth
 滲碳深度

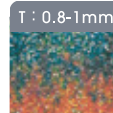
Order Code 訂購編號	L	L1	D	D1	Min-1G2.5 動態平衡	Spanner 扳手規格	Recommended Torsion 推薦鎖固扭力	Torque Wrench 扭力扳手	Center Coolant 中心出水	Side Coolant 側面出水	Pin Collet Pin筒夾
BT40-UC20-70	70	43	45	-	30,000	M8	20Nm	TW30+M08100	✓	✓	✓
BT50-UC20-100	100	62	45	58	20,000	M8	20Nm	TW30+M08160	✓	✓	✓
UC20-150	150	112	45	58	20,000	M8	20Nm	TW30+M08160	✓	✓	✓

- Provide the center coolant and the side coolant.
- 可以選擇中心出水及側面出水的功能。
- Select the side coolant must to use the collet with coolant slot, please check p.20
- 側面出水必須選用有水槽的夾頭，請參閱 p.20
- Select the general collet for center coolant, please check p.19
- 中心出水選用一般的夾頭，請參閱 p.19
- Select the PIN Collet, please check p.21
- 可以選用PIN Collet，請參閱 p.21
- Coolant can be sprayed directly into the edge of tool for quick cooling and remove the steel chip.
- 冷却液可直接噴到刀尖位置，可快速冷却及去除鐵屑。



UC COLLET

UC 黃金夾頭

- Runout <math>< 5\mu\text{m}</math> (4×D)
- 跳動精度 <math>< 5\mu\text{m}</math> (4×D)

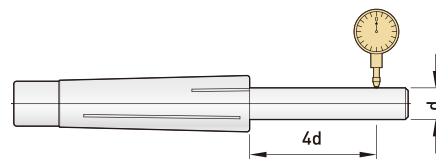

UC 6

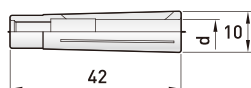

Order Code 訂購編號	(d) 夾持徑
UC6-3	3
4	4
5	5
6	6



UC 10

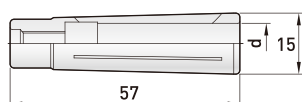

Order Code 訂購編號	(d) 夾持徑
UC10-3	3
4	4
5	5
6	6
8	8
10	10



UC 16 Center Coolant (中心出水)

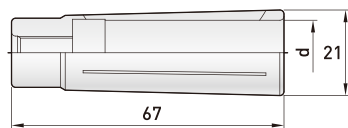

Order Code 訂購編號	(d) 夾持徑
UC16-6	6
8	8
10	10
12	12
14	14
16	16



UC 20 Center Coolant (中心出水)

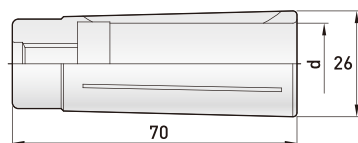

Order Code 訂購編號	(d) 夾持徑
UC20-6	6
8	8
10	10
12	12
16	16
20	20

UC COLLET (Side Coolant)

UC 黃金夾頭 (側邊出水)

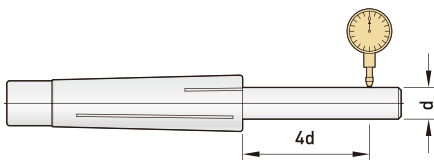

- Coolant can be sprayed directly into the edge of tool, for quick cooling and remove the steel chip.
- 冷却液可直接噴到刀尖位置，可快速冷却及去除鐵屑。

- Runout <math>< 5\mu\text{m}</math> (4×D)
- 跳動精度 <math>< 5\mu\text{m}</math> (4×D)

UC 16F / UC 20F

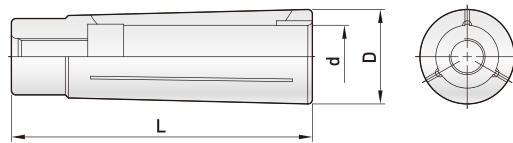

Order Code 訂購編號	(d) 夾持徑	L	D
UC16-6F	6	67	21
8F	8		
10F	10		
12F	12		
14F	14		
16F	16		
UC20-6F	6	70	26
8F	8		
10F	10		
12F	12		
16F	16		
20F	20		

UC PIN COLLET

UC 安卡夾頭

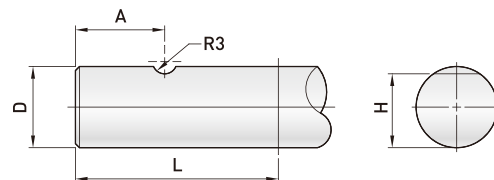
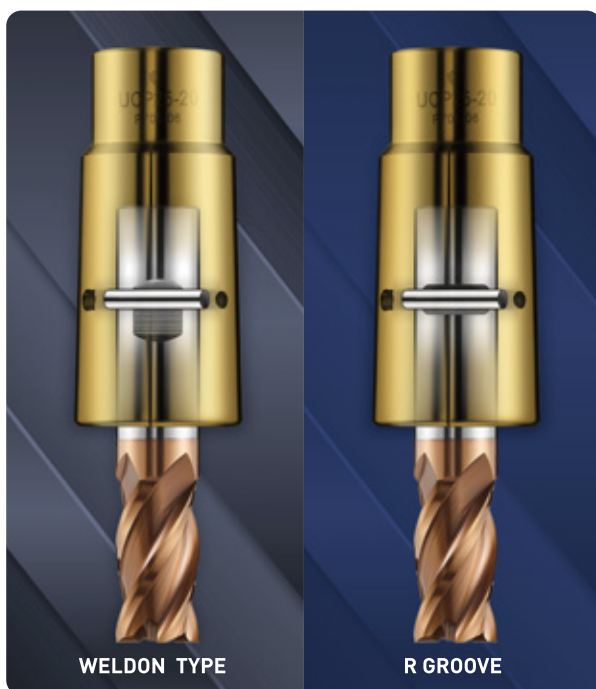

Tool shark Dia.				
D mm	L mm	A mm	H mm	R groove R 型溝槽
6	36	17 ± 2	4.8 ⁰ _{-0.4}	R3
8	40	17 ± 2	6.6 ⁰ _{-0.4}	
10	40	19 ± 2	8.4 ⁰ _{-0.4}	
12	45	21 ± 2	10.4 ⁰ _{-0.4}	
16	48	21 ± 2	14.2 ⁰ _{-0.4}	
20	50	22 ± 2	18.2 ⁰ _{-0.4}	
25	56	29 ± 2	23 ⁰ _{-0.4}	

● Provide the Pin collet for UC20 and UC25. The tools can choose the standard side lock tool (DIN6535HB) or grinded the R groove at tools.

● UC PIN夾頭有UC20及UC25兩個系列可以選擇，刀具必須自行在柄部研磨R型溝槽或者選用標準側固的刀柄 (DIN6535HB)。

UC 20P / UC 25P

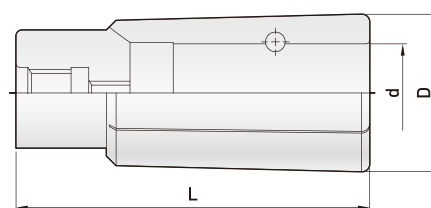

Order Code 訂購編號	(d) 夾持徑	L	D
UC20- 6P	6	70	26
8P	8		
10P	10		
12P	12		
16P	16		
UC25- 12P	12	90	40
16P	16		
20P	20		
25P	25		

FIXED TORQUE SPANNER

固定扭力扳手



Order Code 訂購編號	Torque 扭力值	⊙	L	Tool Item 適用規格
30294-5144	5Nm	4	70	UC6
5146	5Nm	4	115	
5152	7Nm	5	55	UC10
5154	7Nm	5	90	
5156	7Nm	5	140	
5158	7Nm	5	180	
5159	7Nm	5	240	

TORQUE WRENCH

扭力扳手



Order Code 訂購編號	Torque Nm 扭力值	Square Drive 接頭	Length (mm) 長度
TW30	5~30	3 / 8"	300



Order Code 訂購編號	⊙	Length (mm)	Tool Item 適用規格
M06100	6	100	UC16
M06160	6	160	UC16
M06200	6	200	UC16
M08100	8	100	UC20
M08160	8	160	UC20
M10100	10	100	UC25
M10160	10	160	UC25