

ER EXTENSION SLIM CHUCK

ER 筒夾式延長桿

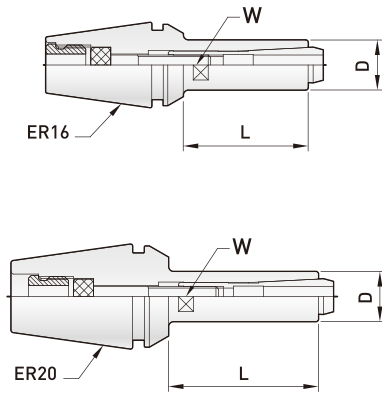

Order Code 訂購編號	Holder 本體規格	Range(d) 夾持範圍	L	D	Spanner 扳手	W	Collet 筒夾
ER16-DC4-25	ER16	2~4	25	9	30194-632	8	DC4
ER20-DC6-35	ER20	1~6	35	14	30194-643	13	DC6

- The tool shank under 2mm must use 3Nm torque wrench.
- The users can more choose for the extension rod of ER collet chuck.
- Extension adaptor includes one hexagon spanner and spanner(A).
- 刀具柄徑在 $\varnothing 2$ 以下，必須使用3Nm的扭力扳手。
- 配合ER本體的延長桿，使用者可以多一種選擇。
- 出貨時附T型扳手及扳手(A)各1支。



DC COLLET (E TYPE)

DC 筒夾 (E型)

DC COLLET RUNOUT

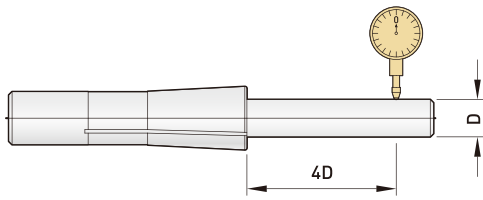

- Runout <math>< 5\mu\text{m}</math> (4×D)
- 跳動精度 <math>< 5\mu\text{m}</math> (4×D)

- The design of E Type collets is emphasized on increase the clamping force of end mills.
- Special designed for end mill.
- E Type筒夾設計重點是強調立銑刀的夾持力。
- 立銑刀專用夾頭。

DC 4 COLLET

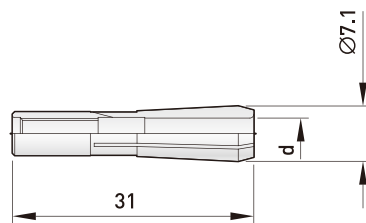

Order Code 訂購編號	(d) 夾持徑
DC4-2E	2
3E	3
4E	4
1/8E	3.175

DC 6 COLLET

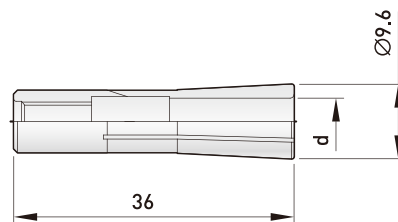

Order Code 訂購編號	(d) 夾持徑
DC6-3E	3
4E	4
5E	5
6E	6
1/8E	3.175
1/4E	6.35

DC6 COLLET (K TYPE) for small shank

DC6 筒夾 (K型) 微小徑專用

DC COLLET RUNOUT

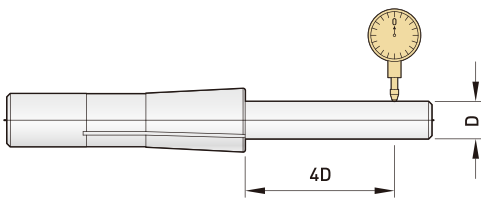

- K Type collets can clamp any type of drills, reamers and taps below $\varnothing 1.9\text{mm}$.
- Gripping range of each type of collets is 0.1mm.
- K Type筒夾，可夾持 $\varnothing 1.9\text{mm}$ 以下的鑽頭、鉸刀、絲攻及銑刀。
- 每一個筒夾的夾持範圍為0.1mm。

- Runout $< 5\mu\text{m} (4\times D)$
- 跳動精度 $< 5\mu\text{m} (4\times D)$

DC 6 COLLET FOR SMALL SHANK

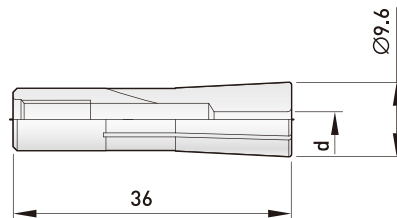

Order Code 訂購編號	d	(d) 夾持徑
DC6-1.0K	1.0	0.9~1.0
1.1K	1.1	1.0~1.1
1.2K	1.2	1.1~1.2
1.3K	1.3	1.2~1.3
1.4K	1.4	1.3~1.4
1.5K	1.5	1.4~1.5
1.6K	1.6	1.5~1.6
1.7K	1.7	1.6~1.7
1.8K	1.8	1.7~1.8
1.9K	1.9	1.8~1.9

DC6 COLLET (D TYPE)

DC6 筒夾 (D型)

DC COLLET RUNOUT

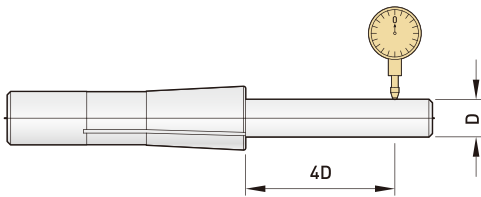

- Runout <math>< 5\mu\text{m}</math> (4×D)
- 跳動精度 <math>< 5\mu\text{m}</math> (4×D)

- D Type collets can clamp any type of drills, reamers and taps below $\varnothing 6\text{mm}$.
- Gripping range of each type of collets is 0.25mm.
- D Type筒夾，可夾持 $\varnothing 6\text{mm}$ 以下的鑽頭、鉸刀、絲攻及銑刀。
- 每一個筒夾的夾持範圍為0.25mm。

DC 6-D COLLET

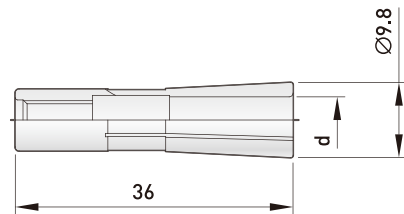

Order Code 訂購編號	d	(d) 夾持徑
DC6- 2D	2	1.75~2.00
2.25D	2.25	2.00~2.25
2.5D	2.5	2.25~2.50
2.75D	2.75	2.50~2.75
3D	3	2.75~3.00
3.25D	3.25	3.00~3.25
3.5D	3.5	3.25~3.50
3.75D	3.75	3.50~3.75
4D	4	3.75~4.00
4.25D	4.25	4.00~4.25
4.5D	4.5	4.25~4.50
4.75D	4.75	4.50~4.75
5D	5	4.75~5.00
5.25D	5.25	5.00~5.25
5.5D	5.5	5.25~5.50
5.75D	5.75	5.50~5.75
6D	6	5.75~6.00