

SD PLUS CHUCK (AM TYPE)

SD 高精度夾頭刀柄 (AM型)

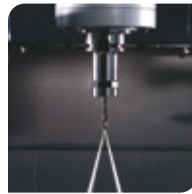

F Type Collet / F型 筒夾

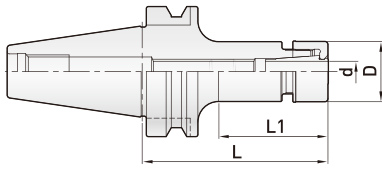
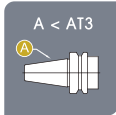

Taper tolerance
錐度公差

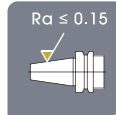

Surface roughness
表面粗度

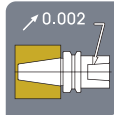

Run out accuracy
內孔偏擺度



Surface hardness
表面硬度

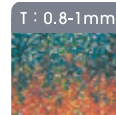

Carbonized depth
滲碳深度

| Order Code 訂購編號 | Range(d) 夾持範圍 | L | L1 | D | Min ⁻¹ G2.5 動態平衡 | Nut 螺帽 | Spanner 扳手 |
|--------------------|------------------|----|----|----|--------------------------------|-----------|---------------|
| BT30-SD6-90AM | 2~6 | 90 | 50 | 20 | 30,000 | CN-SD6AM | 30194-820 |
| SD10-90AM | 2~10 | 90 | 68 | 30 | 30,000 | CN-SD10AM | 30194-830 |
| SD13-75AM | 3~13 | 75 | 50 | 35 | 30,000 | CN-SD13AM | 30194-835 |
| SD16-90AM | 4~16 | 90 | 68 | 42 | 30,000 | CN-SD16AM | 30194-842 |
| BT40-SD6-90AM | 2~6 | 90 | 50 | 20 | 30,000 | CN-SD6AM | 30194-820 |
| SD10-90AM | 2~10 | 90 | 63 | 30 | 30,000 | CN-SD10AM | 30194-830 |
| SD13-90AM | 3~13 | 90 | 55 | 35 | 30,000 | CN-SD13AM | 30194-835 |
| SD16-90AM | 4~16 | 90 | 63 | 42 | 30,000 | CN-SD16AM | 30194-842 |

- Clamping nut design by circular cylinder. Bearing spanner must be used.
- Three types of collet to choose from (1) D type for gripping all type of tools. (2) E type for End mill. (3) F type for coolant supply.
- Bearing spanner and stop screw must be ordered separately.
- 全圓螺帽，必須使用軸承扳手。
- 筒夾有三種類別可選擇 (1) D型：可夾持任何刀具(2) E型：銑刀專用 (3) F型：中心出水刀具使用。
- 軸承扳手及止動螺絲必須另外訂購。



SD COLLET (D TYPE)

SD 筒夾 (D型)

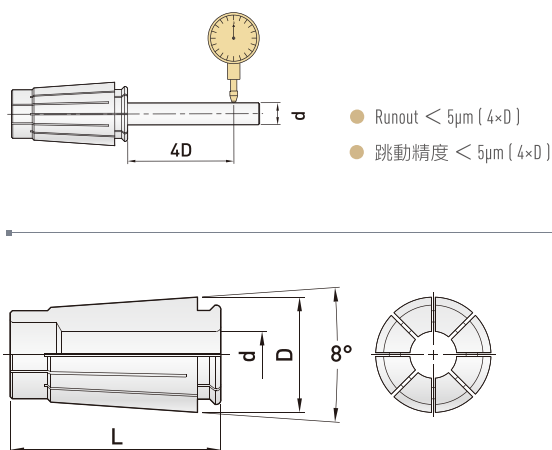

SD6

| Order Code 訂購編號 | d | Range(d) 夾持範圍 | L | D |
|--------------------|------|------------------|----|----|
| SD6-2D | 2 | 1.75~2.00 | 25 | 11 |
| 2.25D | 2.25 | 2.00~2.25 | | |
| 2.5D | 2.5 | 2.25~2.50 | | |
| 2.75D | 2.75 | 2.50~2.75 | | |
| 3D | 3 | 2.75~3.00 | | |
| 3.5D | 3.5 | 3.00~3.50 | | |
| 4D | 4 | 3.50~4.00 | | |
| 4.5D | 4.5 | 4.00~4.50 | | |
| 5D | 5 | 4.50~5.00 | | |
| 5.5D | 5.5 | 5.00~5.50 | | |
| 6D | 6 | 5.50~6.00 | | |

- Gripping range is 0.25mm for collets below 3mm. Gripping range is 0.5mm for collets above 3mm.
- Collets with 3 series, can grip drills, taps, reamers and end mills between 2mm-13mm.
- 3mm以下筒夾，每一個筒夾有0.25mm的夾持範圍；3mm以上筒夾，每一個筒夾有0.5mm的夾持範圍。
- 筒夾分為3大系列，可夾持2mm~13mm的鑽頭、絲攻、絞刀、銑刀。

SD10

| Order Code 訂購編號 | d | Range(d) 夾持範圍 | L | D |
|--------------------|------|------------------|----|----|
| SD10-2D | 2 | 1.75~2.00 | 30 | 16 |
| 2.25D | 2.25 | 2.00~2.25 | | |
| 2.5D | 2.5 | 2.25~2.50 | | |
| 2.75D | 2.75 | 2.50~2.75 | | |
| 3D | 3 | 2.75~3.00 | | |
| 3.5D | 3.5 | 3.00~3.50 | | |
| 4D | 4 | 3.50~4.00 | | |
| 4.5D | 4.5 | 4.00~4.50 | | |
| 5D | 5 | 4.50~5.00 | | |
| 5.5D | 5.5 | 5.00~5.50 | | |
| 6D | 6 | 5.50~6.00 | | |
| 6.5D | 6.5 | 6.00~6.50 | | |
| 7D | 7 | 6.50~7.00 | | |
| 7.5D | 7.5 | 7.00~7.50 | | |
| 8D | 8 | 7.50~8.00 | | |
| 8.5D | 8.5 | 8.00~8.50 | | |
| 9D | 9 | 8.50~9.00 | | |
| 9.5D | 9.5 | 9.00~9.50 | | |
| 10D | 10 | 9.50~10.00 | | |

SD13

| Order Code 訂購編號 | d | Range(d) 夾持範圍 | L | D |
|--------------------|------|------------------|----|----|
| SD13-3D | 3 | 2.75~3.00 | 39 | 20 |
| 3.5D | 3.5 | 3.00~3.50 | | |
| 4D | 4 | 3.50~4.00 | | |
| 4.5D | 4.5 | 4.00~4.50 | | |
| 5D | 5 | 4.50~5.00 | | |
| 5.5D | 5.5 | 5.00~5.50 | | |
| 6D | 6 | 5.50~6.00 | | |
| 6.5D | 6.5 | 6.00~6.50 | | |
| 7D | 7 | 6.50~7.00 | | |
| 7.5D | 7.5 | 7.00~7.50 | | |
| 8D | 8 | 7.50~8.00 | | |
| 8.5D | 8.5 | 8.00~8.50 | | |
| 9D | 9 | 8.50~9.00 | | |
| 9.5D | 9.5 | 9.00~9.50 | | |
| 10D | 10 | 9.50~10.00 | | |
| 10.5D | 10.5 | 10.00~10.50 | | |
| 11D | 11 | 10.50~11.00 | | |
| 11.5D | 11.5 | 11.00~11.50 | | |
| 12D | 12 | 11.50~12.00 | | |
| 12.5D | 12.5 | 12.00~12.50 | | |
| 13D | 13 | 12.50~13.00 | | |

SD COLLET (E TYPE)

SD 筒夾 (E型)

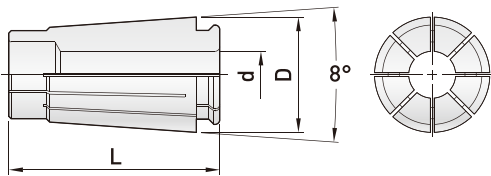
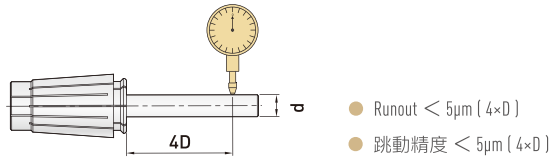

- Gripping torque of SD-E collets is 20% more than SD-D Collets. Can reach high stability during milling.
- Special designed for end mill.

- SD-E筒夾比SD-D筒夾多20%的夾持力，在夾持銑刀加工時，更為安定。
- 立銑刀專用夾頭。

SD6

| Order Code 訂購編號 | d | (d) 持夾徑 | L | D |
|--------------------|-------|------------|----|----|
| SD6-3E | 3 | 3 | 25 | 11 |
| 4E | 4 | 4 | | |
| 6E | 6 | 6 | | |
| 1/8E | 3.175 | 3.175 | | |

SD10

| Order Code 訂購編號 | d | (d) 持夾徑 | L | D |
|--------------------|-------|------------|----|----|
| SD10-3E | 3 | 3 | 30 | 16 |
| 4E | 4 | 4 | | |
| 5E | 5 | 5 | | |
| 6E | 6 | 6 | | |
| 8E | 8 | 8 | | |
| 10E | 10 | 10 | | |
| 1/8E | 3.175 | 3.175 | | |

SD13

| Order Code 訂購編號 | d | (d) 持夾徑 | L | D |
|--------------------|-------|------------|----|----|
| SD13-3E | 3 | 3 | 39 | 20 |
| 4E | 4 | 4 | | |
| 5E | 5 | 5 | | |
| 6E | 6 | 6 | | |
| 8E | 8 | 8 | | |
| 10E | 10 | 10 | | |
| 12E | 12 | 12 | | |
| 1/8E | 3.175 | 3.175 | | |

SD16

| Order Code 訂購編號 | d | (d) 持夾徑 | L | D |
|--------------------|----|------------|----|----|
| SD16-4E | 4 | 4 | 45 | 25 |
| 5E | 5 | 5 | | |
| 6E | 6 | 6 | | |
| 8E | 8 | 8 | | |
| 10E | 10 | 10 | | |
| 12E | 12 | 12 | | |
| 14E | 14 | 14 | | |
| 16E | 16 | 16 | | |

SD20

| Order Code 訂購編號 | d | (d) 持夾徑 | L | D |
|--------------------|----|------------|----|----|
| SD20-6E | 6 | 6 | 50 | 30 |
| 8E | 8 | 8 | | |
| 10E | 10 | 10 | | |
| 12E | 12 | 12 | | |
| 14E | 14 | 14 | | |
| 16E | 16 | 16 | | |
| 20E | 20 | 20 | | |

SD COLLET (F TYPE)

SD 筒夾 (F型)

- SD-F collet provide through-coolant capability.
- The collet combine with nut.
- SD-F筒夾具有中心出水的功能。
- 筒夾出貨時，內含螺帽。



F Type Collet / F型 筒夾



Fig 2 / 圖號 2



Fig 1 / 圖號 1

| Order Code 訂購編號 | Chuck Type 刀柄規格 | (d) 持夾徑 | Contains 內容 | | Fig 圖號 |
|--------------------|--------------------|------------|-------------|-----------|-----------|
| | | | Collet 筒夾 | Nut 螺帽 | |
| SAC10- 3F | SD10 | 3 | SD10- 3F | CN-SD10A | 1 |
| 4F | | 4 | 4F | | |
| 6F | | 6 | 6F | | |
| 8F | | 8 | 8F | | |
| 10F | | 10 | 10F | | |
| SAM10- 3F | SD10 | 3 | SD10- 3F | CN-SD10AM | 2 |
| 4F | | 4 | 4F | | |
| 6F | | 6 | 6F | | |
| 8F | | 8 | 8F | | |
| 10F | | 10 | 10F | | |
| SAC13- 3F | SD13 | 3 | SD13- 3F | CN-SD13A | 1 |
| 4F | | 4 | 4F | | |
| 5F | | 5 | 5F | | |
| 6F | | 6 | 6F | | |
| 8F | | 8 | 8F | | |
| 10F | | 10 | 10F | | |
| 12F | 12 | 12F | | | |
| SAM13- 3F | SD13 | 3 | SD13- 3F | CN-SD13AM | 2 |
| 4F | | 4 | 4F | | |
| 5F | | 5 | 5F | | |
| 6F | | 6 | 6F | | |
| 8F | | 8 | 8F | | |
| 10F | | 10 | 10F | | |
| 12F | 12 | 12F | | | |
| SAC16- 6F | SD16 | 6 | SD16- 6F | CN-SD16A | 1 |
| 8F | | 8 | 8F | | |
| 10F | | 10 | 10F | | |
| 12F | | 12 | 12F | | |
| 14F | | 14 | 14F | | |
| 16F | | 16 | 16F | | |
| SAM16- 6F | SD16 | 6 | SD16- 6F | CN-SD16AM | 2 |
| 8F | | 8 | 8F | | |
| 10F | | 10 | 10F | | |
| 12F | | 12 | 12F | | |
| 14F | | 14 | 14F | | |
| 16F | | 16 | 16F | | |

SD NUT (AC TYPE)

SD 螺帽 (AC型)



Fig 1 / 圖號 1



Fig 2 / 圖號 2

| Order Code 訂購編號 | Fig 圖號 | Outside Dia 外徑 | Collet 筒夾規格 |
|--------------------|-----------|-------------------|----------------|
| CN-SD6A | 1 | 20 | SD6 |
| SD10A | 1 | 29 | SD10 |
| SD13A | 1 | 37 | SD13 |
| SD16A | 1 | 41 | SD16 |
| SD20A | 2 | 50 | SD20 |

SD NUT (AM TYPE)

SD 螺帽 (AM型)



| Order Code 訂購編號 | Outside Dia 外徑 | Collet 筒夾規格 |
|--------------------|-------------------|----------------|
| CN-SD6AM | 20 | SD6 |
| SD10AM | 30 | SD10 |
| SD13AM | 35 | SD13 |
| SD16AM | 42 | SD16 |

SD NUT (B TYPE)

SD 螺帽 (B型)



| Order Code 訂購編號 | Collet 筒夾規格 |
|--------------------|----------------|
| CN-SD20B | SD20 |

SPANNER

扳手



Fig 1 / 圖號 1

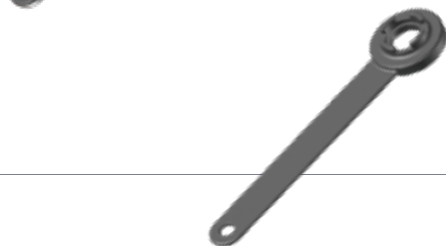

Fig 2 / 圖號 2

| Order Code 訂購編號 | Fig 圖號 | Type 型式 |
|--------------------|-----------|------------|
| 30194-917 | 1 | SP-SD6 |
| 925 | 1 | SP-SD10 |
| 932 | 1 | SP-SD13 |
| 936 | 1 | SP-SD16 |
| 702 | 2 | SP-SD20 |



| Order Code 訂購編號 | Type 型式 | Nut 螺帽規格 |
|--------------------|------------|-------------|
| 30194-820 | SP-SR20 | SD6AM |
| 30194-830 | SP-SR30 | SD10AM |
| 30194-835 | SP-SR35 | SD13AM |
| 30194-842 | SP-SR42 | SD16AM |



| Order Code 訂購編號 |
|--------------------|
| SP-SD20B |